

PRODUCT SPECIFICATION

Part Number
PDM57116x-B01

Details

- Dot Matrix LED Display
- 5x7 Array with X-Y Select
- Available in Common Column Anode or Common Column Cathode
- Emitting Color: Blue

Features

- Low power consumption
- RoHS Compliant
- Gray or Black Face, White Segment
- Easy mounting on PCB or socket

Mechanical Dimensions

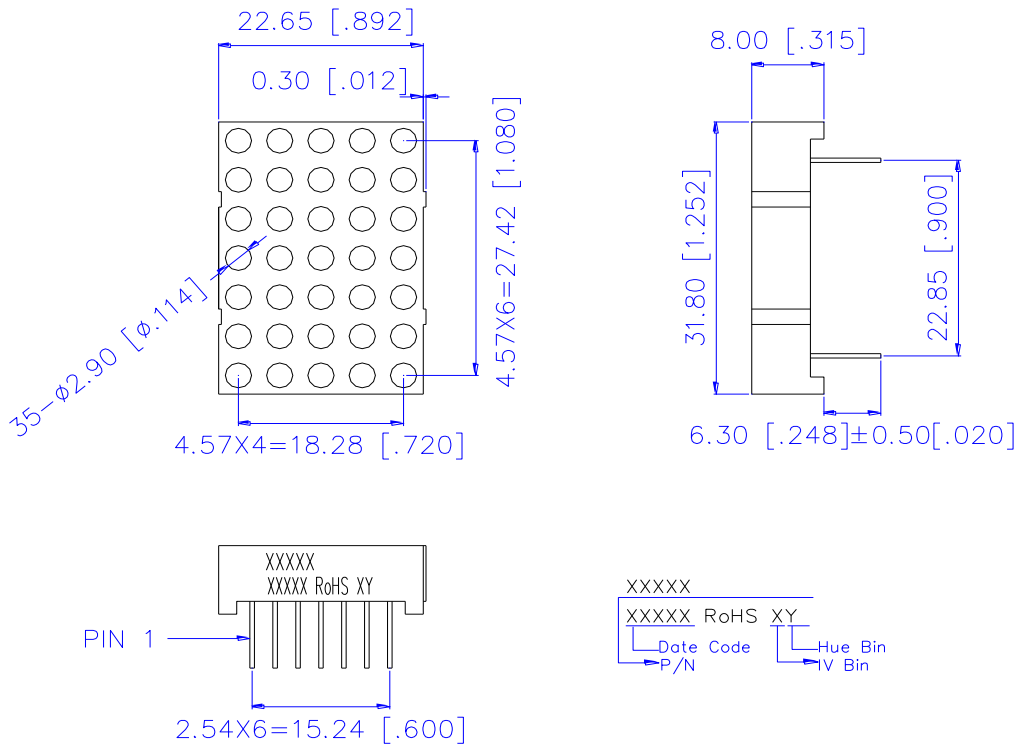

Notes:

1. Dimensions in millimeters [inch], and tolerance is ± 0.25 [.010] and angle is $\pm 1^\circ$ unless otherwise noted.
2. Bending \leq Length*1%
3. All pins are $\varnothing 0.50$ [.020] ± 0.1 [.004]
4. Specifications subject to change without notice.





Device Selection Guide

Model Number	Chip		Description	Note
	Material	Emitting Color		
PDM57116C-B01	InGaN	Blue	Common Col. Cathode	Gray Face, White Segment Comes Standard*
PDM57116A-B01			Common Col. Anode	

*Note: 1. Add "--BW" to end of Part Number for Black Face, White Segment version

Absolute Maximum Ratings at Ta=25°C

Parameter	Symbol	Rating	Unit
Power Dissipation per Dice	PAD	114	mW
Derating Liner from 25°C per Dice	--	0.4	mA/°C
Continuous Forward Current Per Dice	IAF	30	mA
Peak Current Per Dice (duty cycle 1/10, 1KHz)	IPF	100	mA
Reverse Voltage Per Dice	VR	5	V
Electrostatic Discharge (HBM)	ESD	1000	V
Operating Temperature	Topr	-35 ~ +85	°C
Storage Temperature	Tstg	-35 ~ +85	°C
Solder Conditions: 1/16 inch below seating plane for 3 -5 seconds at 260°C			

Typical Electrical and Optical Characteristics at Ta=25°C

Parameter	Symbol	Min.	Typ.	Max.	Unit	Condition
Forward Voltage Per Segment	VF	--	3.2	3.8	V	IF=20mA
Luminous Intensity Per Segment	Iv	--	45	--	mcd	IF=10mA
Dominant Wavelength	λd	--	465	--	nm	IF=20mA
Reverse Current	IR	--	--	50	μA	VR=5V
Luminous Intensity Matching Ratio	Iv-m	--	--	2:1	--	IF=10mA

Luminous General Iv Bin Grade (IF = 10mA)

A	B	C	D	E	F	G	H	J	K	L	M
0.627	0.816	1.062	1.382	1.797	2.337	3.039	3.952	5.138	6.681	8.686	11.293
0.815	1.061	1.381	1.796	2.336	3.038	3.951	5.137	6.680	8.685	11.292	14.681
N	P	Q	R	S	T	U	V	W	X	Y	1
14.682	19.088	24.815	32.261	41.940	54.523	70.881	92.146	119.791	155.730	202.450	263.185
19.087	24.814	32.260	41.939	54.522	70.880	92.145	119.790	155.729	202.449	263.184	342.141
2	3	4	5	6	7	8	9				
342.142	444.786	578.222	751.690	977.198	1270.359	1651.467	2146.908				
444.785	578.221	751.689	977.197	1270.358	1651.466	2146.907	2790.981				

Remark: Unit=mcd

*Tolerance: ±20%

Color Rank Limits (IF = 20mA)

2	3	4	5	6
456.0	459.0	462.0	465.0	468.0
459.0	462.0	465.0	468.0	471.0

Remark: Unit=nm

*Tolerance: ±1

Typical Electrical/Optical Characteristic Curves

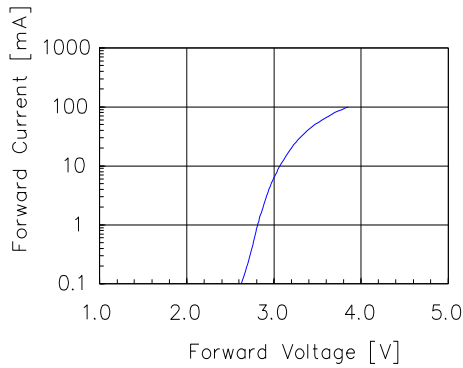

Fig 1. Forward Current vs. Forward Voltage

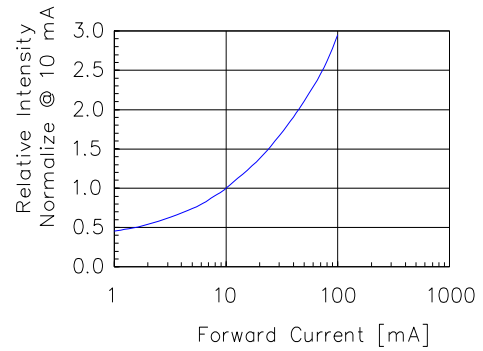

Fig 2. Relative Intensity vs. Forward Current

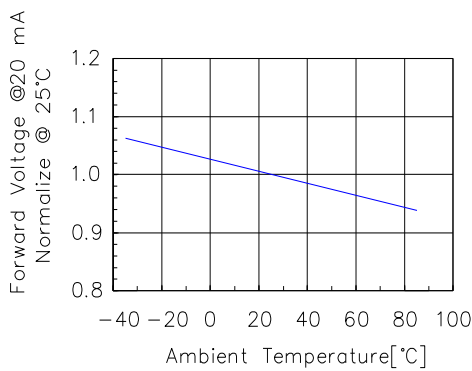

Fig 3. Forward Voltage vs. Temperature

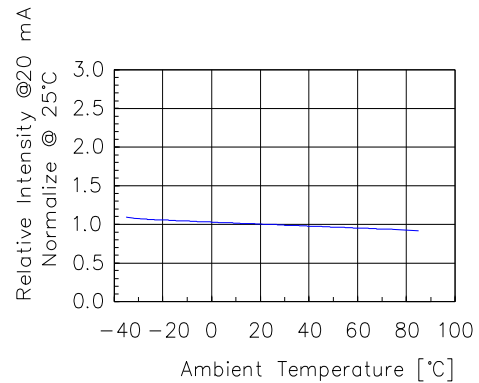

Fig 4. Relative Intensity vs. Temperature

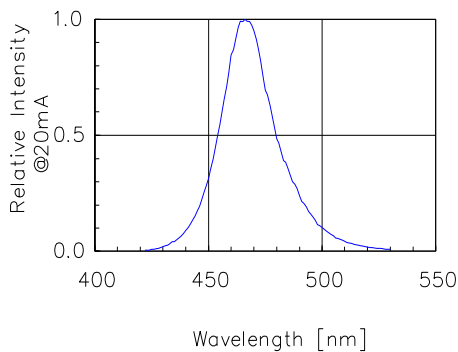

Fig 5. Relative Intensity vs. Wavelength

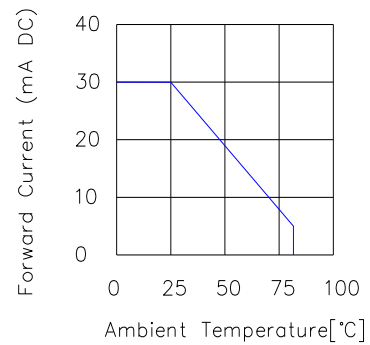
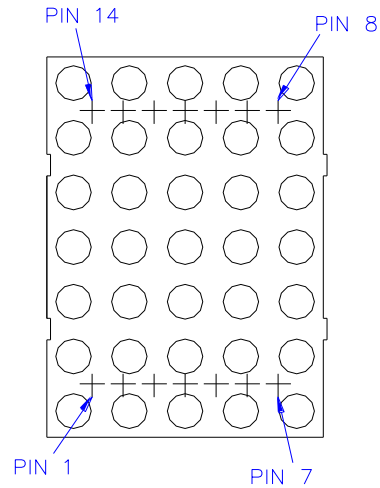
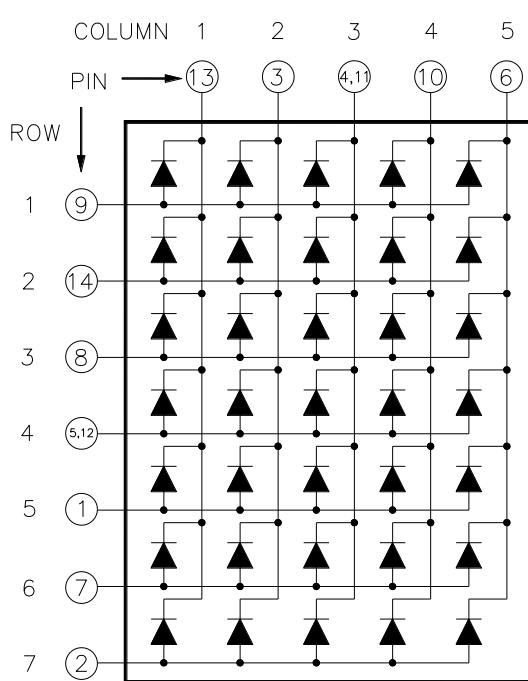

Fig 6. Forward Current vs. Ambient Temperature

All Light-On Segments Feature & Pad Position



Internal Circuit Diagram



PDM57116C-B01 Common Column Cathode

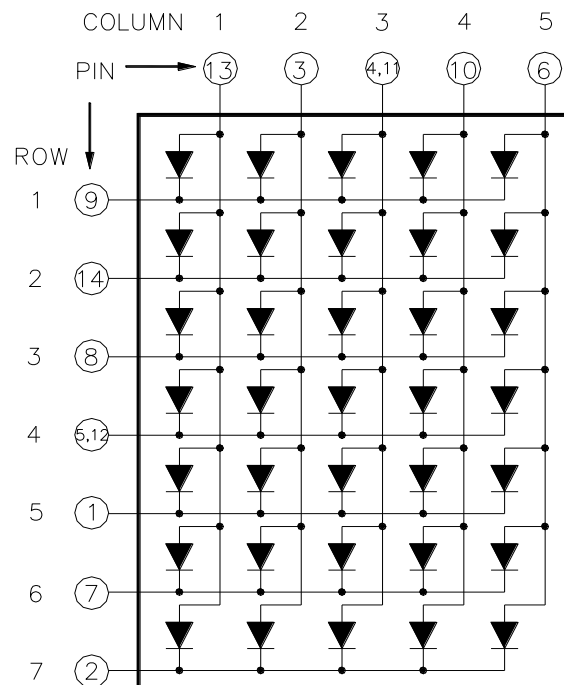

PDM57116A-B01 Common Column Anode

Precautions for Use

1. Recommended soldering conditions

1.1. Wave soldering

Basic SPEC is ≤ 5 sec. When 260°C . If temperature is higher, time should be shorter ($+10^{\circ}\text{C} \rightarrow -1$ sec.).

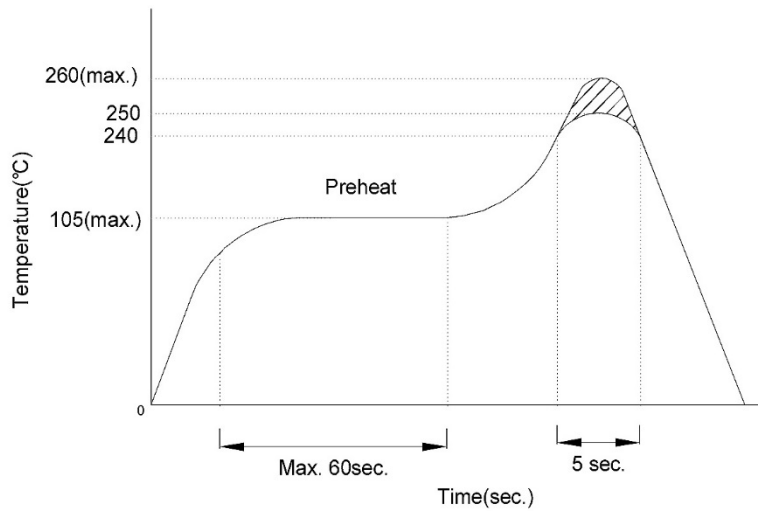

1.2. Soldering Iron:

Power dissipation of iron should be smaller than 15W and temp should be controllable. Soldering temperature should be under 260°C , time ≤ 3 sec.

Packaging Specifications

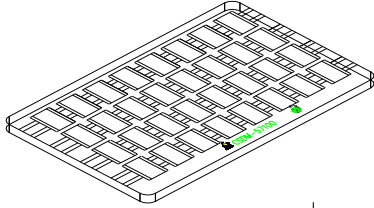

1 Tray From Box = 32 PCS
Tray Size:
L300 x W190 x H18mm

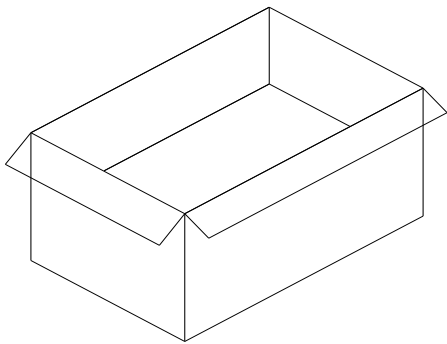
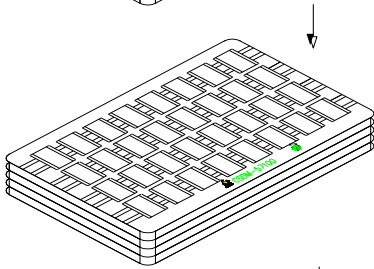

12 Trays Per Inner Box
Q'TY: 384 PCS.
Box Size:
L300 x W205 x H240mm

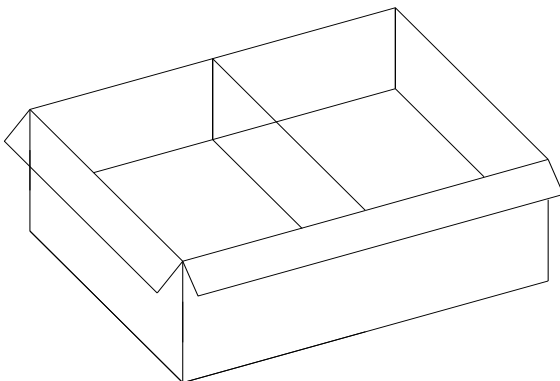

2 Inner Boxes Per Carton.
Total Q'TY: 768 Pcs
Carton Size:
L431 x W320 x H252mm



Customer Approval Signatures

Print Name	Signature	Date	Notes/Remarks

Record Of Revisions

Rev.	Comments	Page	Date
0	Released Spec	--	10/25/13