

# PRODUCT SPECIFICATION

*Part Number*  
**PLC763-WCB04**

## *Details*

- Piranha LED
- 7.62 x 7.62 x 9.4mm
- Emitting Color Blue
- InGaN Dice Used

## *Features*

- 5mm Lens
- High Luminous Output
- High Current Operation
- RoHS Compliant

## *Mechanical Dimensions*

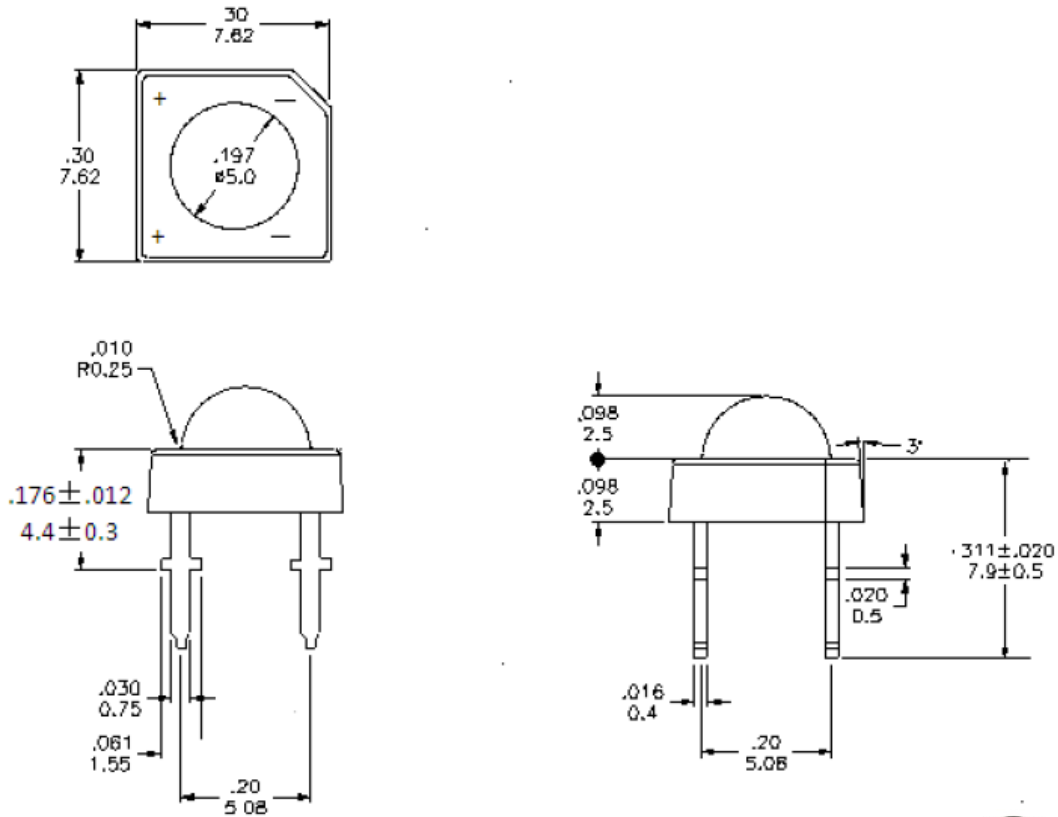

### Notes:

1. Dimensions in millimeters [inch], and tolerance is  $\pm 0.25$  [ $.010$ ] unless otherwise noted.
2. Specifications subject to change without notice





**Device Selection Guide**

Model Number	Chip	
	Material	Emitting Color
PLC763-WCB04	InGaN	Blue

**Absolute Maximum Ratings at Ta=25°C**

Parameter	Symbol	Rating	Unit
		B	
Power Dissipation	PAD	266	mW
Continuous Forward Current	IAF	70	mA
Peak Current (duty cycle 1/10, 1KHz)	IPF	100	mA
Reverse Voltage	VR	5	V
Electrostatic Discharge (HBM)	ESD	1500	V
Operating Temperature	Topr	-30~+80	°C
Storage Temperature	Tstg	-40~+100	°C
Soldering Conditions	Max. 260°C for 5 sec Max.(3mm from the epoxy body)		

**Electrical and Optical Characteristics at Ta=25°C**

Parameter	Symbol	Min.	Typ.	Max.	Unit	Condition
Forward Voltage	VF	--	3.4	3.8	V	IF=30mA
Luminous Flux	Iv	1000	2000	--	mlm	
Dominant Wavelength	$\lambda D$	--	470	--	nm	
Viewing Angle	2 $\theta$ 1/2	--	90	--	deg	
Reverse Current	IR	--	--	50	$\mu$ A	VR=5V

***Luminous Flux Rank Limits ( IF = 30mA )***

Code	Unit: mlm	
	Min.	Max.
B	1000	1500
C	1500	2000
D	2000	2500
E	2500	3000

***Dominant Wavelength Rank Limits ( IF = 30mA )***

Code	Unit: nm	
	Min.	Max.
B5	460	465
B6	465	470
B7	470	475

***Forward Voltage Rank Limits ( IF = 30mA )***

Code	Unit: V	
	Min.	Max.
I	2.8	3.0
J	3.0	3.2
K	3.2	3.4
L	3.4	3.6
M	3.6	3.8

Notes:

1. Tolerance of measurement of luminous Flux:  $\pm 15\%$
2. Tolerance of measurement of Dominant wavelength:  $\pm 2\text{nm}$
3. Tolerance of measurement of forward voltage:  $\pm 0.05\text{v}$
4. All data measured by P-tec's test equipment
5. One delivery will include several color rank, VF and Iv ranks of the products.
6. The quantity-ratio of the ranks is decided by P-tec
7. Please confirm with P-tec salesman, if your request differs from standard specifications.

### Typical Electrical/Optical Characteristic Curves

- $T_a=25^{\circ}\text{C}$  Unless Otherwise Noted

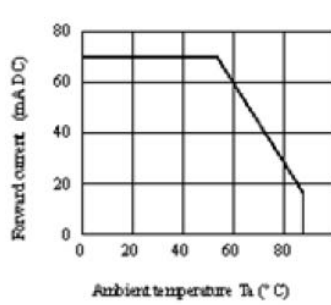

Fig 1. Forward Current Vs. Ambient Temperature

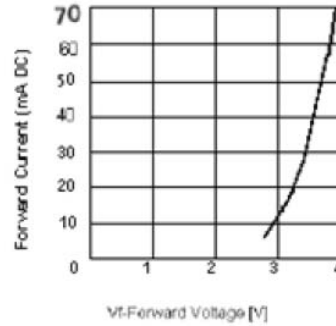

Fig.2 Forward Current Vs. Forward Voltage

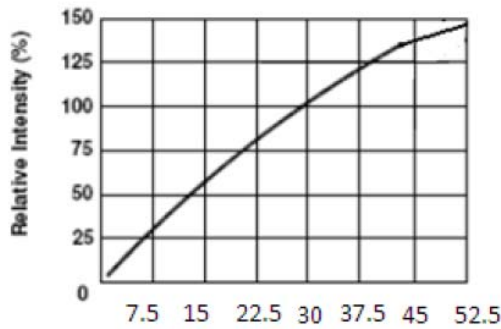

Fig 3. Relative Intensity Vs. Forward Current

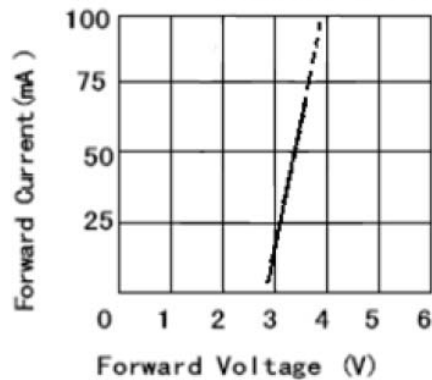

Fig.4 Peak Forward Voltage Vs. Forward Current (100us test pulse, 1% duty cycle)

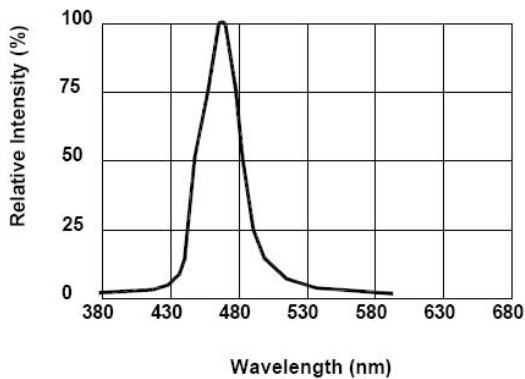

Fig 5. Relative Intensity Vs. Wavelength

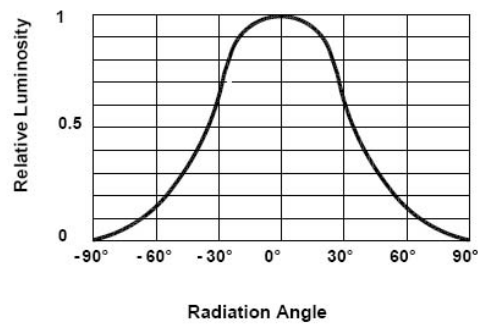

Fig 6. Radiation Diagram

## *Precautions for Use*

### 1. Recommended soldering conditions

#### 1.1. Wave soldering

Basic SPEC. is  $\leq 5\text{sec.}$  When  $260^{\circ}\text{C}$ . If temperature is higher, time should be shorter ( $+10^{\circ}\text{C} \rightarrow -1\text{sec.}$ ).

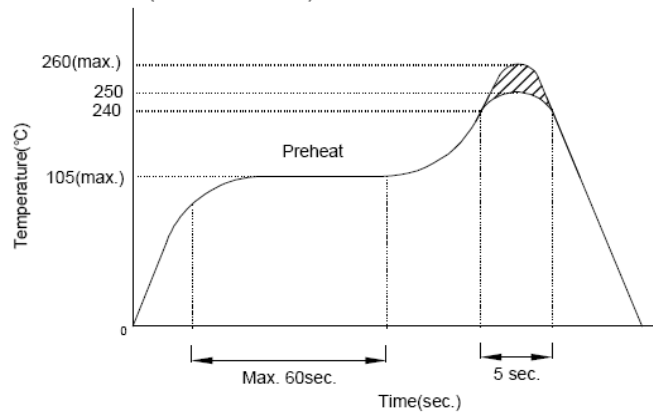

#### 1.2. Recommended Soldering:

Power dissipation of iron should be smaller than 15W and temperature should be controllable.  
Soldering temperature should be under  $230^{\circ}\text{C}$ , time 3sec.

### 2. Static Electricity

#### 2.1 Static electricity or surge voltage damages LEDs.

It is recommended that a wrist band or an anti-electrostatic glove be used when handling the LEDs.

2.2 All devices, equipment and machinery must be properly grounded. It is recommended that measures be taken against surge voltage to the equipment that mounts the LEDs.

